

TRACK LIGHT GANEKO 35W

Características

- Larga vida útil. Más de 50.000 horas
- Alta eficiencia lumínica
- Hasta un 80% de ahorro
- IP 20

Aplicaciones

- Es adecuado para supermercados, tiendas especializadas, vitrinas, salas de exposiciones, donde la atención se centra en enfatizar puntos visuales especiales

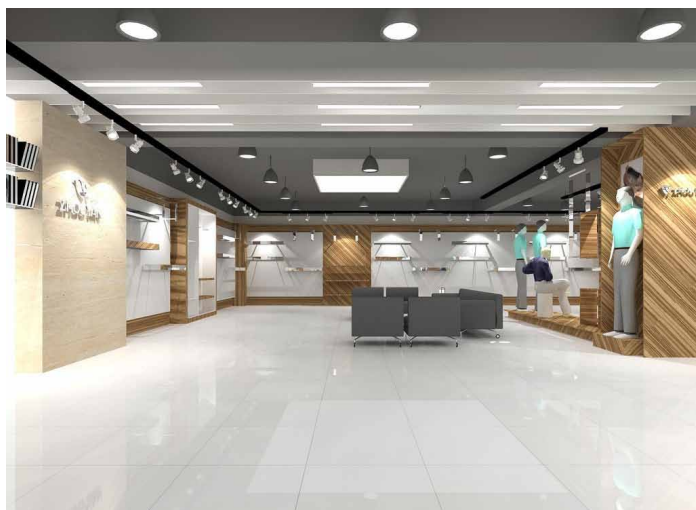

Especificaciones Técnicas del Producto

CCT	2700K	3000K	4000K
LUMENES	3.055 Lm	3.180 Lm	3.360 Lm
POTENCIA	35W		
MODELO	GAN-35W		
REGULABLE	No		
VOLTAJE	AC100-240V		
FRECUENCIA	50/60 Hz		
FACTOR DE POTENCIA	≥0.9		
CRI	≥90		
ÁNGULO DEL HAZ	15°/24°/45°/60°		
CORRIENTE SALIDA	820 mA		
Tª FUNCIONAMIENTO	-20 ~45°C		
Tª ALMACENAMIENTO	-20 ~65°C		
IP	IP 20		
VIDA ÚTIL	40.000 horas		
DIMENSIONES	161*110*234mm		

Dimensiones

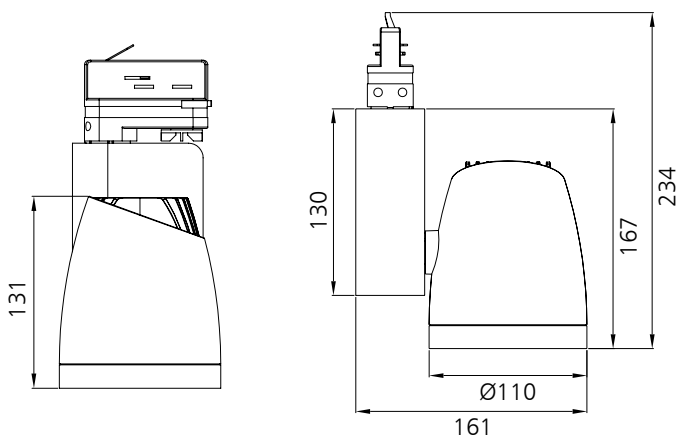

Información Embalaje

CONTENIDO	MEDIDAS CARTON (cm) L*A*H	PESO BRUTO	PESO NETO
8 PC/CTN	56*40,5*28,5	13,6 kg	10,4 kg

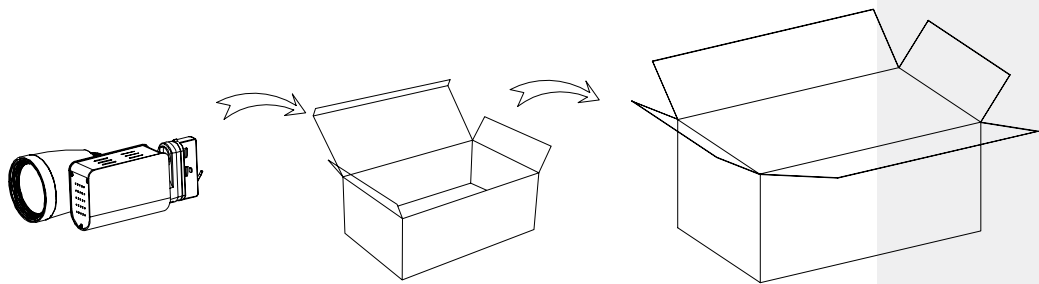

Especificaciones Ópticas

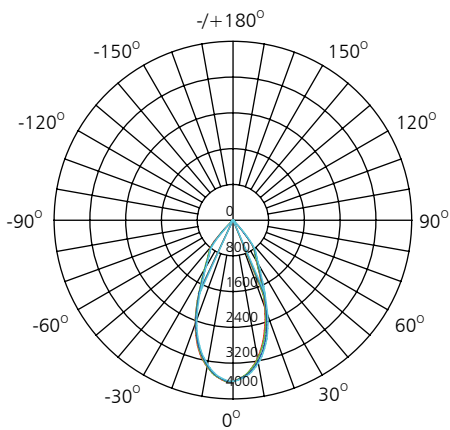

UNIT: cd

- C0/180, 47.2 deg
- C30/210, 47.6 deg
- C60/240, 47.9 deg
- C90/270, 48.0 deg

AVERAGE BEAM ANGLE (50%): 47.7DEG

Especificaciones Ópticas

2700 K

3000 K

Distribución espectral



Diagrama de intensidad polar



Diagrama cartesiano de intensidad

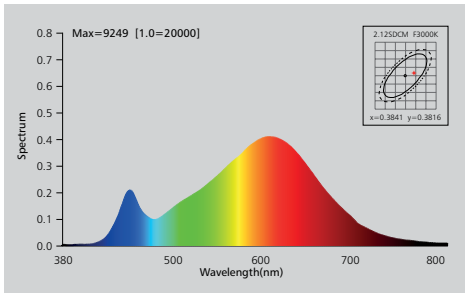
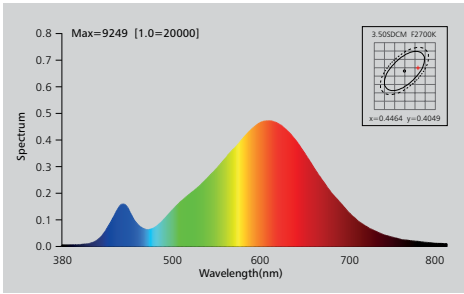

Diagrama de haz

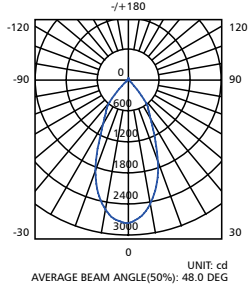
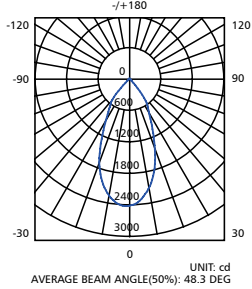

Height Eavg, Emax Angle: 48.17deg Diameter
Note: The Curves indicate the illuminated area and the average illumination when the Luminaire is at different distance.

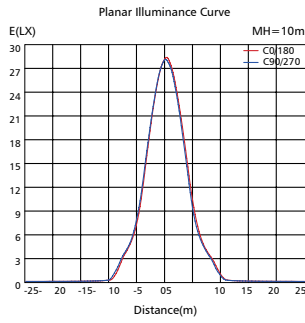
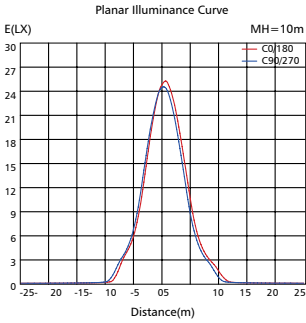
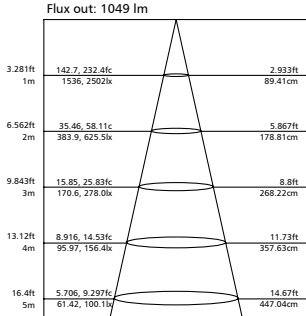
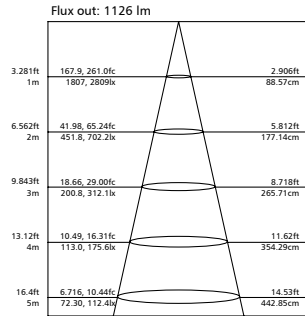

Height Eavg, Emax Angle: 47.77deg Diameter
Note: The Curves indicate the illuminated area and the average illumination when the Luminaire is at different distance.

Especificaciones Ópticas

4000 K

Distribución espectral



Diagrama de intensidad polar



Diagrama cartesiano de intensidad

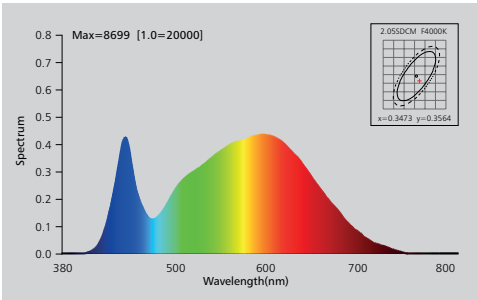

Diagrama de haz

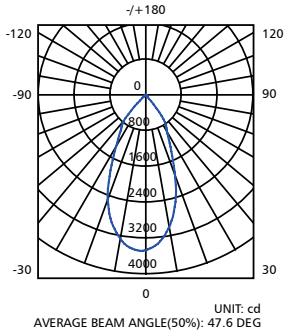

Instalación

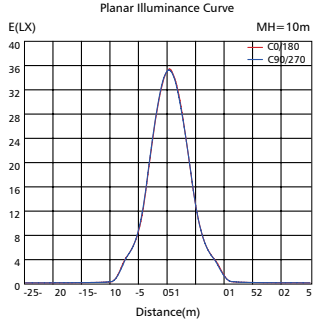
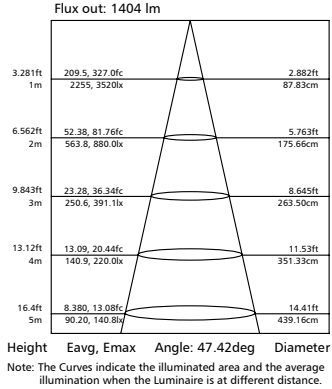